



| | |
|-------------------|--|
| Dimensions | |
| CHAIR SIZE | W41" / D41" / SD24" / H34" / SH18" |
| HALF COT SIZE | W50" / D41" / SD24" / H34" / SH18" |
| TWIN SIZE | W66" / D41" / SD24" / H34" / SH18" |
| FULL SIZE | W72" / D41" / SD24" / H34" / SH18" |
| QUEEN SIZE | W78" / D41" / SD24" / H34" / SH18" |
| KING SIZE | W88" / D41" / SD24" / H34" / SH18" |
| Material | Leather or fabric High density foam Metal Down (optional) Wood legs |
| Options | Sections + configuration Upholstery Bed sizes from chair to king Premier foam, softer gel, or Tempur-Pedic mattress Wood legs |
| Details | 87 inches of bedroom-length sleeping surface High-density, high-resiliency foam seat cushions Lifetime warranty on frame 10-year mechanism warranty |

prices subject to change | delivery not included

AMERICAN LEATHER® TODAY SLEEPER

BARIS

Standard Features:

- Premium high-density, high-resiliency foam seat
- Loose back and tight seat cushions
- Unique seat cushion design doubles as a mattress section
- Zero wall clearance
- Single-needle top-stitch
- Limited lifetime warranty on frame
- Limited three-year warranty on mechanism
- Quick-ship delivery

Options:

- Wood legs in Dune, Ebony, Mink, or Oiled Ash finish

Mattress:

- Four inches of high-density, high-resiliency foam

Leg height is 4"

Please use actual leather, fabric, Crypton®, Sunbrella® and Ultrasuede® swatches when specifying furniture as the colors shown may vary due to the printing process.

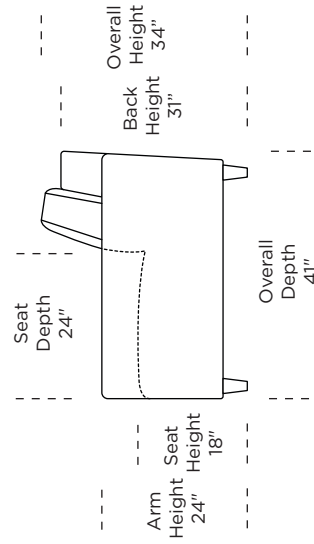
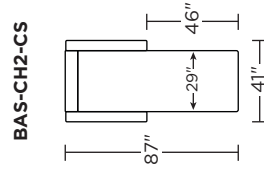
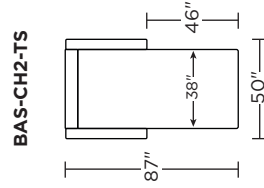
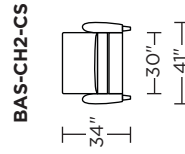
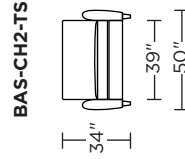
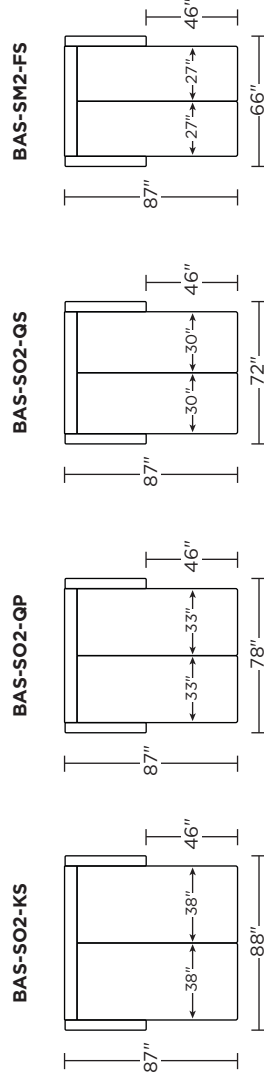
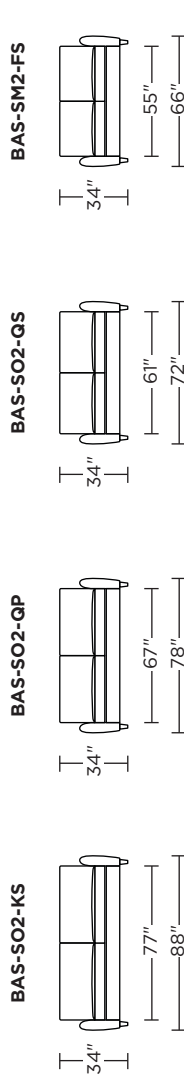

Scale: 1/8 inch = 1 foot
All dimensions are approximate and subject to change.
Specify components from the sitting position.

VII.30.23